

SCALE

INNOVATIVE RACING SUSPENSION

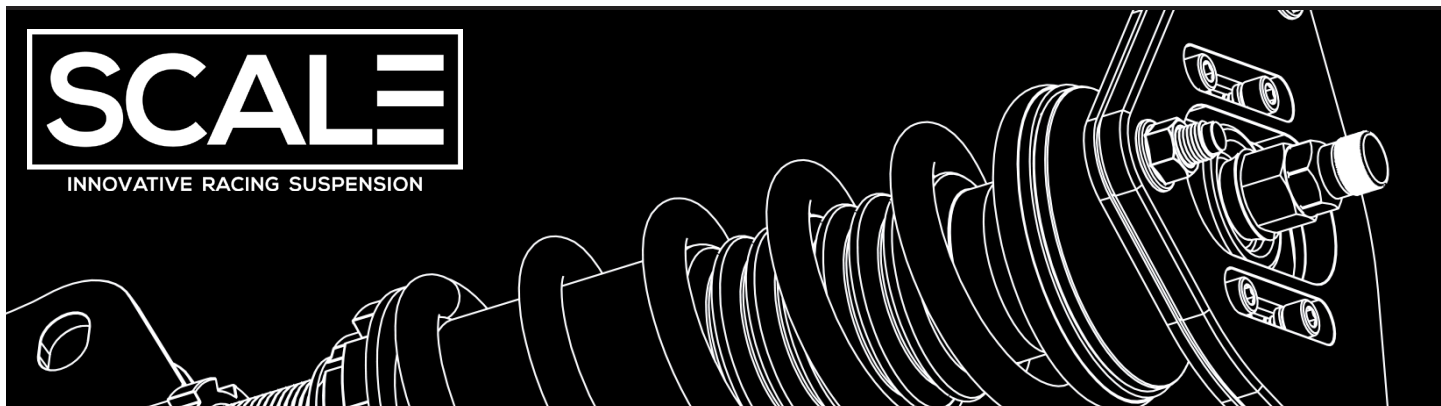

USER MANUAL

FRONT | DOUBLE WISHBONE
REAR | MULTI LINK

SCALE_DOC2_2020-V1

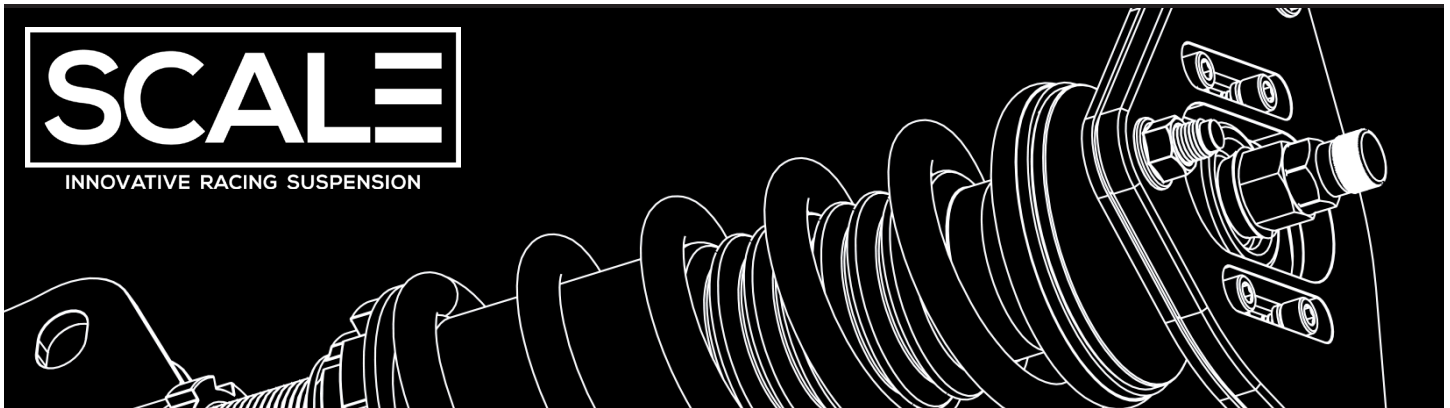

IMPORTANT NOTICE

The purpose of this document is to provide the user a complete installation guide for Scale Suspension products. A proper application and use are important for a better longevity of the product. Failure to follow instructions may result in uncomfortable driving experience and possible damages to the suspension components.

CONTACT YOUR AUTHORIZED DEALER

REPLACEMENT PARTS OR OTHER INSTALL INFORMATIONS

If replacement parts are needed call your authorized dealer. Most parts can be ordered separately and shipped within a day. Tech support is also available by emailing tech@scalesuspension.com.

FIRST STEPS

1. Please read the instructions carefully before starting the installation process.
2. All Scale Suspension products come with a **two years factory warranty**. Contact tech@scalesuspension.com for any questions or claim.
3. Every Scale Suspension system must be installed by a certified technician. A wrong installation may result in potential damage to the suspension components or danger while driving.
4. Scale Suspension is not responsible for any damage or danger if customers do not follow properly the instructions for installing the products correctly.
5. When disassembling or installing the upper mounts, please do not use an air wrench. Too much torque will cause some damage to the threads or the nuts or loosen internal parts. If you absolutely have to use an air wrench use the lowest possible torque setting.
6. After adjusting the length of the shock absorbers **please use a hammer and a metal punch to tighten the ring in place**. If these parts are not tightened together properly that it can loose while driving and result in operating noise and damage may occur.
7. Make sure to properly secure the ABS sensor cables and brake lines on their brackets. Not doing so may result in damage and danger while driving.
8. Inspect the shock absorbers frequently. Make sure every bolts and lock rings are well tightened.
9. Product is for OFF-ROAD USE ONLY.

LUBRIFICATION CARE

It is very important to apply or spread anti-seize grease over the threaded areas to provide an uniform film to keep the adjustment easier. The threaded portion is subject to seize in corrosive environments; salt, snow, dirt, acid, etc.

DO NOT NEGLECT! Make sure to apply anti-seize to avoid the seizure of parts together. **Seized parts are not covered by warranty.**

Before the initial installing process we suggest to remove the lower mounts and apply anti-seize on the lower mount threads to ensure a total protection of the threaded area.

**Lubricate the pillow-balls at each motor oil change with penetrating oil.*

SCALE

INNOVATIVE RACING SUSPENSION

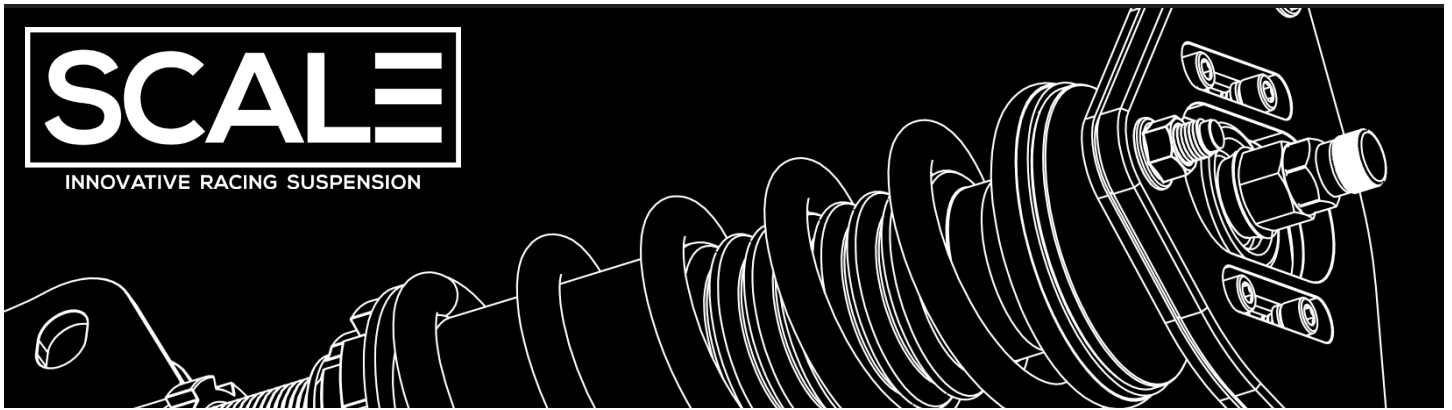

FRONT & REAR PRELOAD ADJUSTMENTS

No preload adjustment has been done to your suspension system when you received it. You must follow the instructions to correctly preload your suspension system. Preload can be set before installation or when it has been already installed on the car.

- 1 - Hold the spring in its highest position (close to the top plate)
- 2 - Spin the spring seat and locking collar upwards until it makes contact with the spring.
- 3 - When the spring seat reaches the bottom of the uncompressed spring, turn the spring seat upwards to add preload on the spring.
- 4 - Spring preload may vary on some certain applications. If no other specs are indicated in the box (see image on the right), we suggest a 5 to 10mm preload.
- 5 - Use a measuring tape to calculate the applied preload on the spring by measuring the overall length of the spring. As an example, a 180mm extended spring will measure 170mm with a 10mm preload.

! IMPORTANT !

***First of all make sure to apply same preload on each side otherwise it can be difficult to adjust the ride height afterwards**

***Please ensure that the spring seat lock rings are tightened correctly before driving**

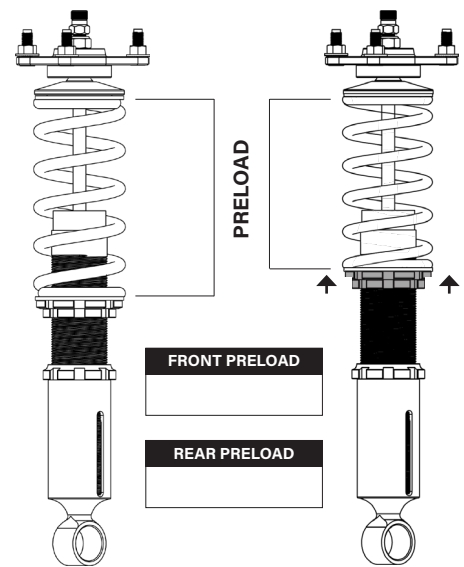

FRONT & REAR RIDE HEIGHT ADJUSTMENTS

To adjust the ride height to your specific needs, you can do it while the suspension has been already installed on the vehicle. There is no need to uninstall the suspension. Both sides need to be adjusted at the same time or it may be complicated if one side is still touching the ground.

- 1 - Use the provided wrenches to loosen the lower mount lock ring.
- 2 - Turn the cylinder in a counter clockwise direction to lift the vehicle. Turn the opposite direction to lower the vehicle. After adjustment, tighten the rings with a hammer and a metal punch.
- 3 - Do not try to adjust the ride height by the spring seat, lowering the car by the spring seat may result in internal damages and affecting driving performance.

! IMPORTANT !

***Always adjust the ride height by the lower mount to adjust the overall shock length**

***Use the scaled lower mount opening to make sure to adjust both sides at the same height**

***Top of the opening window is the safety limit for shock adjustment (extension)**

***Once the lower lock rings are well tightened against each other with the help of the adjustment wrenches provided in your kit, give an extra safeness by turning the lock rings with a hammer and a punch before driving for the first time**

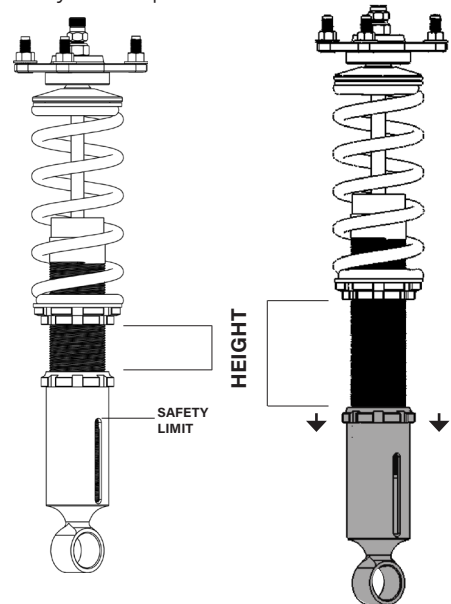

SCALE

INNOVATIVE RACING SUSPENSION

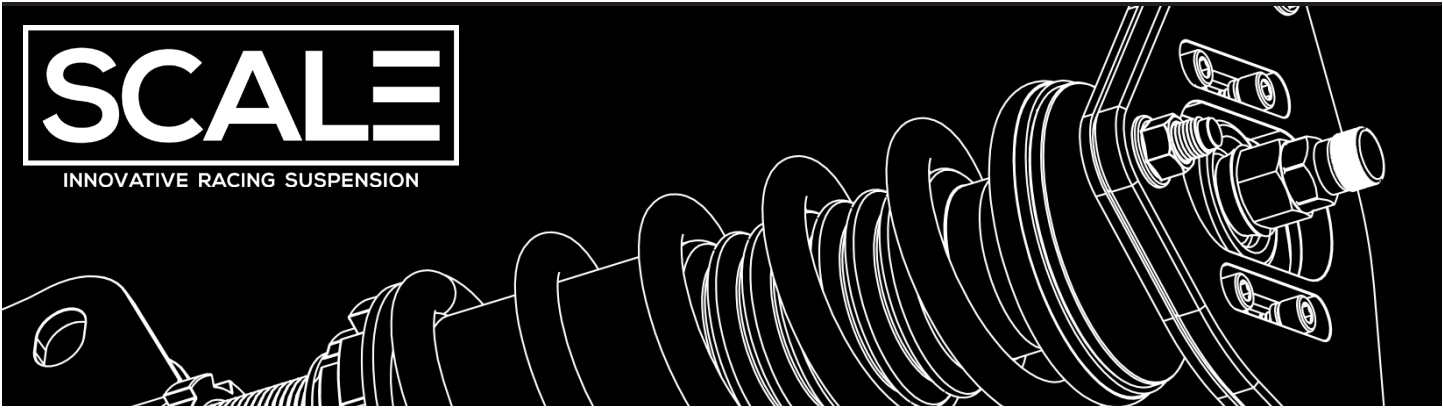

DAMPING ADJUSTMENT

24 ADJUSTABLE DAMPING LEVELS

Our suspension systems have been designed with a manual damping efficiency adjustment. The compression and rebound are adjustable through 24 levels. For increasing the damping stiffness, turn the adjustment button clockwise and to decrease turn it counter clockwise.

1 - Adjust the damping to a medium setting (position 12 out of 24) for the first tries. Fine tune if needed to set your desired comfort level.

2 - Changing the damping affects both the compression and rebound speed of the suspension. Do not skip too much clicks at once but rather try to increase/decrease two clicks at a time.

! IMPORTANT !

***If you drive your vehicle in cold weather set the damping to a lower level. For a winter use set the damping to 2 - 4.**

***A damping level of 2 in winter (sub zero temperature) is the same as a damping level of 12 in summer.**

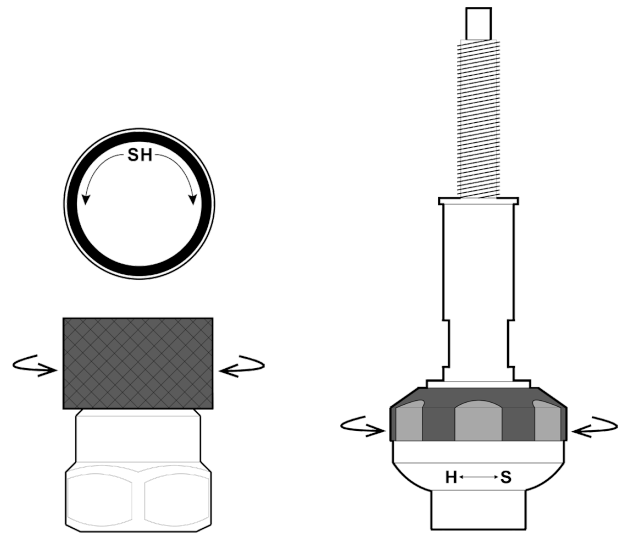

FRONT KNOB

REAR KNOB

SHARE YOUR EXPERIENCE

If you have any questions, comments or even experiences to share with the conception team please email us to tech@scalesuspension.com. You can also reach the team on Facebook and Instagram. It is important for us to receive your constructive feedbacks for improving rigourously our products.



TELEPHONE
+1 888 239 0770



EMAIL (GENERAL)
info@scalesuspension.com



FACEBOOK
SCALE Suspension



INSTAGRAM
[@scalesuspension](https://www.instagram.com/scalesuspension)

